

MH 310 501/MH 310 701/MH 310 801 MOH 310 501/MOH 310 701/MOH 310 801

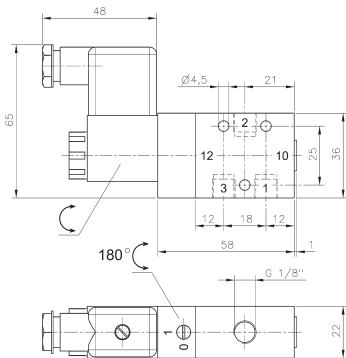

MH 310 501/MOH 310 501

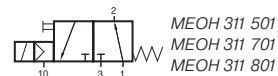
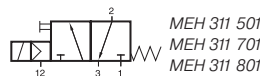
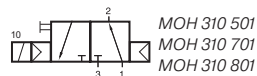
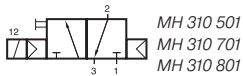
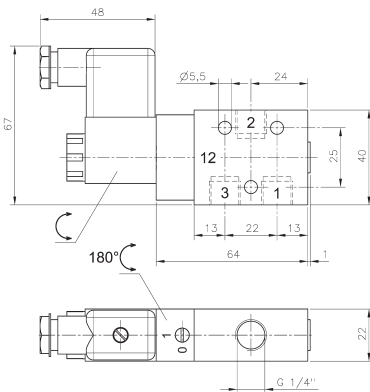

MH 310 701/MOH 310 701

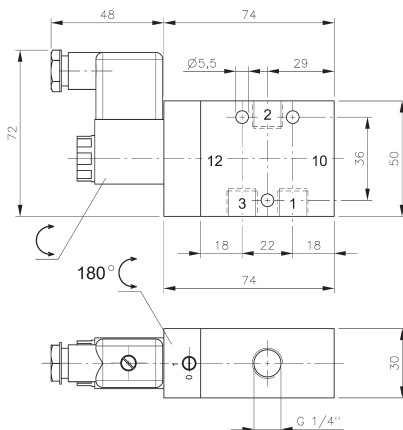

MH 310 801/MOH 310 801



3/2-way solenoid valve normally closed (MH) or normally open (MOH) actuated by permanent signal and equipped with air spring return.

Available with solenoid operators:
230V/50Hz, 110V/50Hz, 24V/50Hz, 48V=, 24V=, 12V=.

Valves are generally equipped with manual override. If requested without manual override please order M 310 ___ / MO 310 ___

Valves are also available with external pilot feed. Type: MEH 311 ___ (n.c.) or MEOH 311 ___ (n.o.). Port 12 series 501 and 701 M5, series 801 G 1/8". Minimum actuation pressure: 3 bar. Version for vacuum on request.

Please notice:
Do not close port 3 to convert into a 2-way valve.

Type	Function	Port size	Air flow	Operating press.	Power consumption	Weight
MH 310 501	n.c.	G 1/8"	650 l/min	2 - 10 bar	3 W = / 5 VA ~	0,19 kg
MH 310 701	n.c.	G 1/4"	1250 l/min	2 - 10 bar	3 W = / 5 VA ~	0,21 kg
MH 310 801	n.c.	G 1/4"	1450 l/min	1,5 - 10 bar	3 W = / 5 VA ~	0,39 kg
MOH 310 501	n.o.	G 1/8"	650 l/min	2 - 10 bar	3 W = / 5 VA ~	0,19 kg
MOH 310 701	n.o.	G 1/4"	1250 l/min	2 - 10 bar	3 W = / 5 VA ~	0,21 kg
MOH 310 801	n.o.	G 1/4"	1450 l/min	1,5 - 10 bar	3 W = / 5 VA ~	0,39 kg